

PREFABRIKOVANÝ SEPTIK – PRAVÝ

max. OBJEM 3,1m³

PŮDORYS

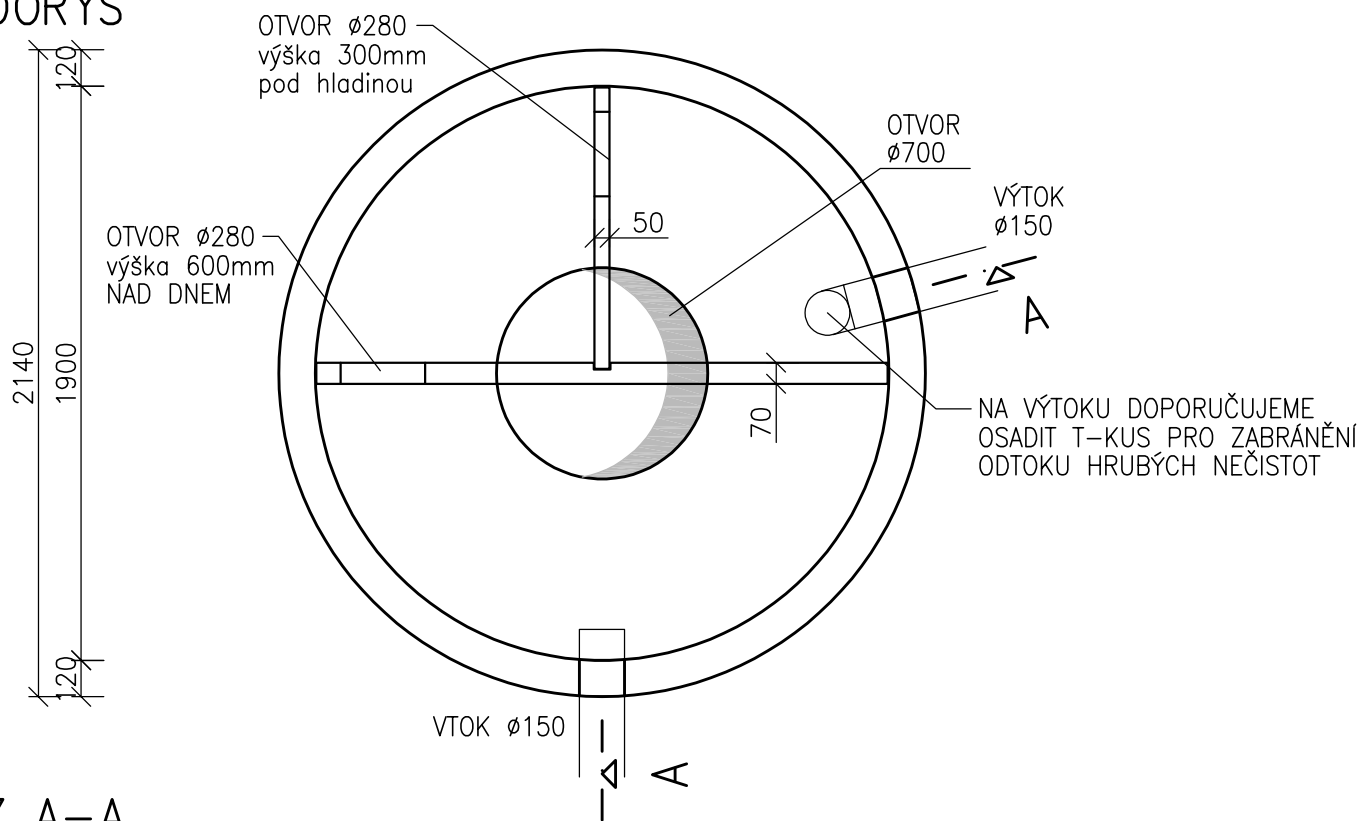

ŘEZ A-A

